

GFID-71

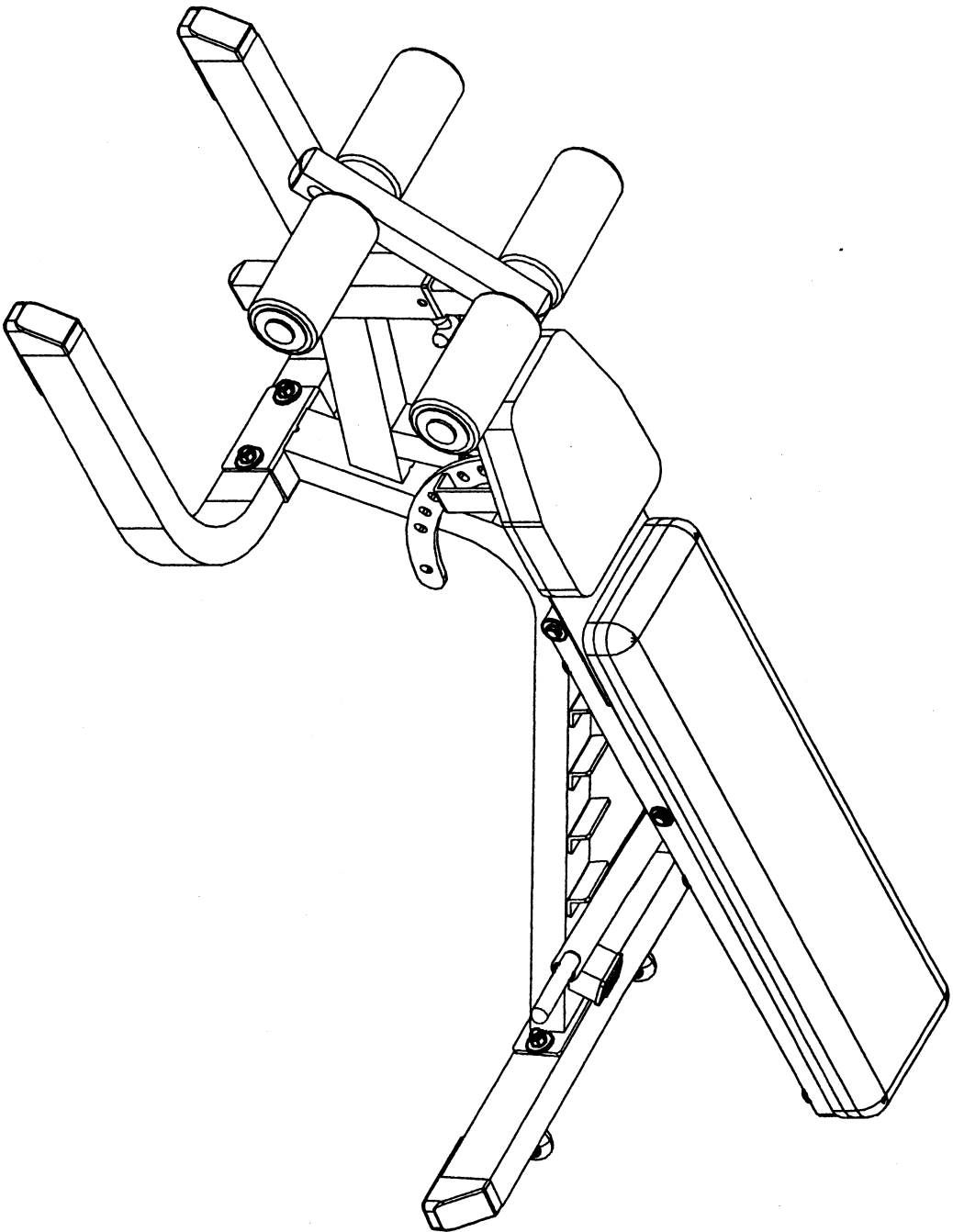

















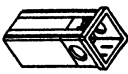

VERSION 0506

GFID-71 HARDWARE ILLUSTRATION SHEET

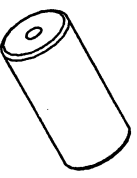
A1.	M12X80 HEX HEAD BOLT	[4PCS]
A2.	5/16"X2 1/4" HEX HEAD BOLT	[6PCS]
A3.	5/16"X1" HEX HEAD BOLT	[4PCS]
A4.	M8X45 HEX HEAD BOLT	[2PCS]
B1.	M12 NYLON LOCK NUT	[4PCS]
B2.	M8 NYLON LOCK NUT	[2PCS]
C1.	5/16"(I.D) WASHER	[10PCS]
C2.	5/16" SPRING WASHER	[10PCS]
C3.	M12(I.D) WASHER	[8PCS]
C4.	M8(I.D) WASHER	[4PCS]
D1.	Ø1" ROUND END CAP (8341-033)	[4PCS]
D2.	60X45 NYLON BUSHING (9211-032)	[1PCS]
D3.	45X45 END CAP (9211-091)	[3PCS]
D4.	60X45 NYLON BUSHING (9211-047)	[1PCS]
D5.	2"X2"X1.8 END CAP (9211-087)	[1PCS]
D6.	20X40 END CAP (9211-008)	[2PCS]
D7.	FOAM ROLLER (9161-009)	[4PCS]
D8.	Ø3" NYLON WASHER (9214-008)	[4PCS]
D9.	2"X3" FOOT CAP (9211-048)	[4PCS]
D10.	38X38 RUBBER BAR CATCH (9310-001)	[1PCS]
D11.	Ø64 PULLEY (9213-023)	[2PCS]

Qty.

A1		A2		A3		A4		B1	
B2		C1		C2		C3		C4	
D1		D2		D3		D4		D5	
D6		D7		D8		D9		D10	
D11									

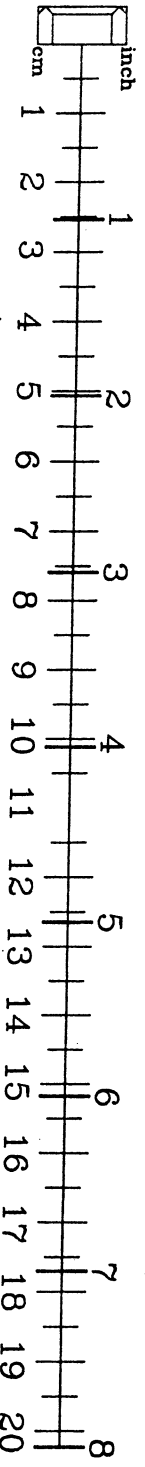

GFID-71 PARTS ILLUSTRATION SHEET

A[1PCS]

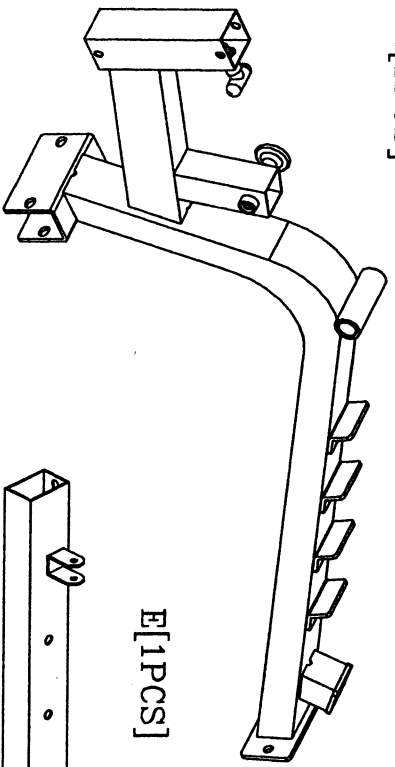

D[2PCS]

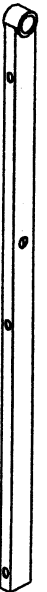

G[1PCS]

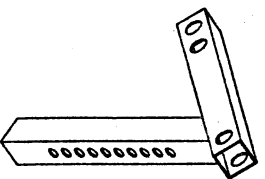

E[1PCS]

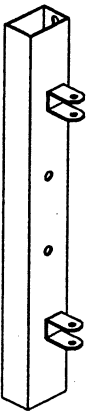

I[1PCS]

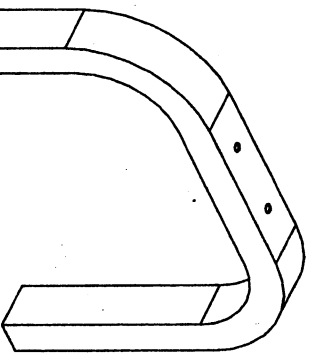

F[1PCS]

N[1PCS]



J[1PCS]
9121-051

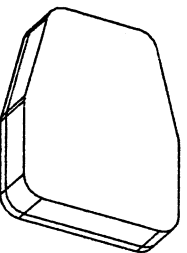

C[1PCS]

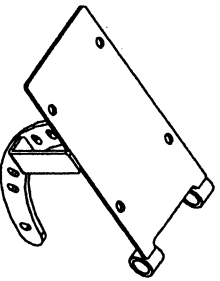

M[1PCS]
9125-011

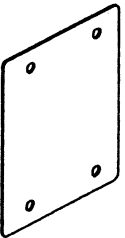

K[1PCS]
9112-021

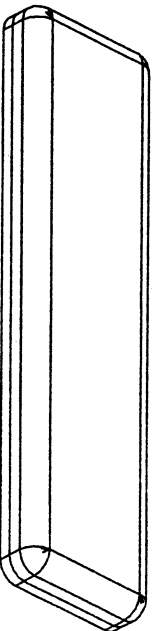

H[2PCS]



PAGE 2

